



UniFi[®] | SWITCH 8 150W

Managed PoE+ Gigabit Switch
with SFP

Model: US-8-150W

QUICK START GUIDE

Introduction

Thank you for purchasing the Ubiquiti Networks® UniFi® Switch. This Quick Start Guide is designed to guide you through the installation and also includes the warranty terms.

Package Contents



UniFi Switch



Power Cord



Mount Brackets
(Qty. 2)



Bracket Screws
(M4, Qty. 8)



Mounting Screws
(M4, Qty. 4)



Screw Anchors
(M4, Qty. 4)



Quick Start
Guide

System Requirements

- Linux, Mac OS X, or Microsoft Windows 7/8/10
- Java Runtime Environment 1.6 (1.8 or newer recommended)
- Web Browser: Mozilla Firefox, Google Chrome, Microsoft Edge, or Microsoft Internet Explorer 11
- UniFi Controller software v5 or above (recommended) or v4.8.x (offers possibly reduced feature set) available at: **downloads.ubnt.com/unifi**

TERMS OF USE: All Ethernet cabling runs must use CAT5 (or above). It is the customer's responsibility to follow local country regulations, including operation within legal frequency channels, output power, indoor cabling requirements, and Dynamic Frequency Selection (DFS) requirements.

Network Topology Requirements

- A DHCP-enabled network for the UniFi Switch to obtain an IP address (connected devices will also obtain IP addresses after deployment)
- A UniFi Cloud Key or management station running the UniFi Controller software v5 or above (recommended) or v4.8.x (possibly offering reduced feature set), located either on-site and connected to the same Layer 2 network, or off-site in a cloud or NOC

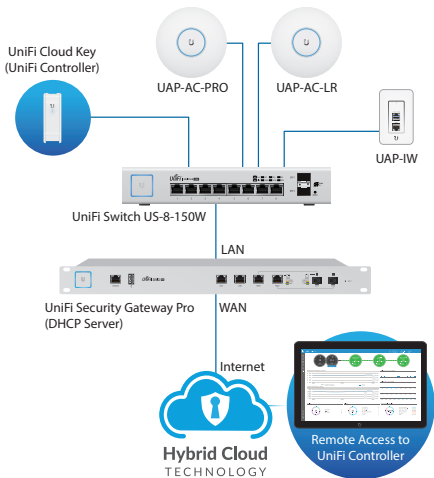

Sample Network Diagram

All UniFi devices support off-site management controllers. For setup details, refer to the User Guide on the website: documentation.ubnt.com/unifi

Hardware Overview

Front Panel

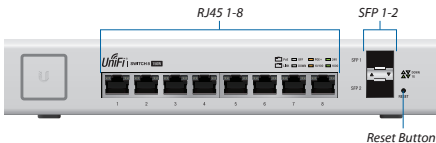

Port	Description
RJ45 1-8	RJ45 ports support 10/100/1000 Ethernet connections and Power over Ethernet (PoE).
SFP 1-2	Hot-swappable SFP ports support 1 Gbps connections.
Reset Button	This button serves two functions for the UniFi Switch: <ul style="list-style-type: none">• Restart Press and release the <i>Reset</i> button quickly.• Restore to Factory Default Settings Press and hold the <i>Reset</i> button for more than five seconds.

Back Panel



Port	Description
AC Power	Connect the included <i>Power Cord</i> to the <i>AC Power</i> port.

LEDs

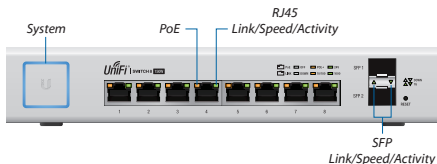

System LED

State	Status
Flashing White	Initializing.
Steady White	Factory defaults, waiting for integration.
Alternating White/Blue	Device is busy; do not touch or unplug it. This usually indicates that a process such as a firmware upgrade is taking place.
Steady Blue	Successfully integrated into a network and working properly.
Flashing Blue	This is used to locate a device. When you click Locate in the UniFi Controller software, the <i>System</i> LED will flash blue. The software will also display the location of the UniFi Switch on the map.

RJ45 LEDs

LED	State	Status
PoE	Off	No PoE
	Amber	IEEE 802.3af/802.3at
	Green	24V Passive
Link/ Speed/ Activity	Off	No Link
	Amber	Link Established at 10/100 Mbps Flashing Indicates Activity
	Green	Link Established at 1000 Mbps (1 Gbps) Flashing Indicates Activity

SFP LEDs

LED	State	Status
Link/ Speed/ Activity	Off	No Link
	Green	Link Established at 1 Gbps Flashing Indicates Activity

Side Panels

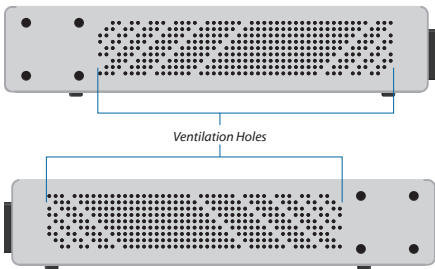

- !** **WARNING:** FAILURE TO PROVIDE PROPER VENTILATION MAY CAUSE FIRE HAZARD. KEEP AT LEAST 20 MM OF CLEARANCE NEXT TO THE VENTILATION HOLES FOR ADEQUATE AIRFLOW.
- !** **WARNING:** The US-8-150W must not be stacked. Do not place it on top of another switch. Do not place anything on top of the US-8-150W.

Hardware Installation

! **WARNING:** To reduce the risk of fire or electric shock, do not expose the switch to rain or moisture.

Shelf Mounting

1. Position the two *Mount Brackets* as shown below, and attach the brackets using the eight *Bracket Screws*.

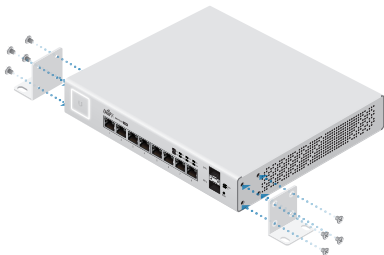

2. Secure the UniFi Switch to the shelf using the four *Mounting Screws*.

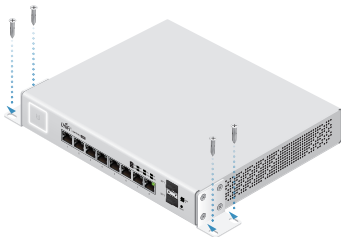

Wall Mounting

1. Position the two *Mount Brackets* as shown below, and attach the brackets using the eight *Bracket Screws*.

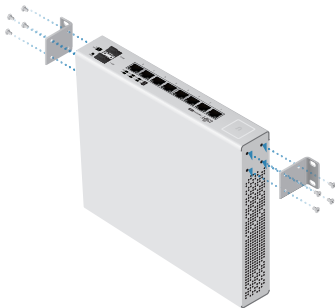

2. Attach the UniFi Switch to the wall using the four *Screw Anchors* and four *Mounting Screws*.

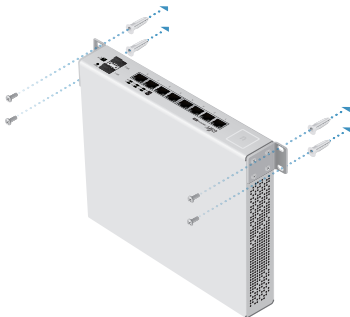

Connecting Power

1. Connect the *Power Cord* to the power port on the back of the UniFi Switch.



2. Plug the *Power Cord* into a power outlet.

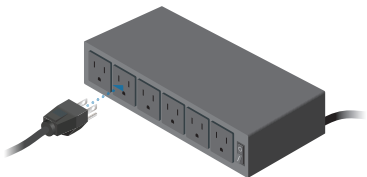

Connecting Ethernet

1. Connect an Ethernet cable from your DHCP server or LAN to any port on the UniFi Switch.

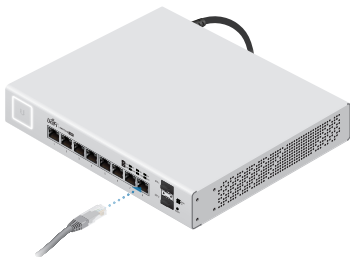

2. Connect your computer or host system and other devices to the other ports on the UniFi Switch.

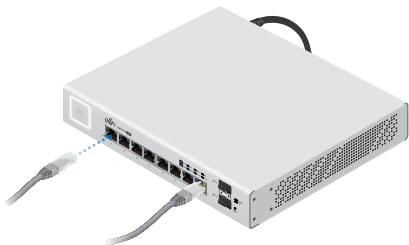

Using SFP Ports

To use an *SFP* port:

1. Remove the dust plug covering the *SFP* port.
2. Insert a compatible fiber SFP module into the *SFP* port.

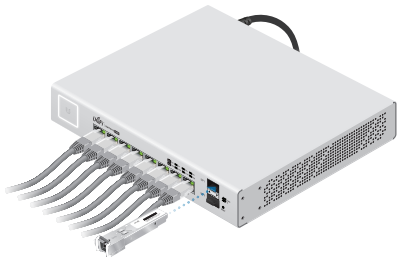

3. Connect the fiber optic cable to the fiber SFP module.

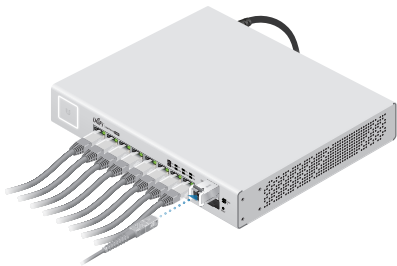

For information about compatible fiber SFP modules, visit:
community.ubnt.com/unifi

Software Installation

Download and install the latest version of the UniFi Controller software at downloads.ubnt.com/unifi and follow the on-screen instructions.

 **Note:** If you already have UniFi Controller v4.8.x or above installed, skip to the section, *Adopting the UniFi Switch*.

After you have installed the software and run the UniFi Installation Wizard, a login screen will appear for the UniFi Controller management interface. Enter the admin name and password that you created and click **Log In**.

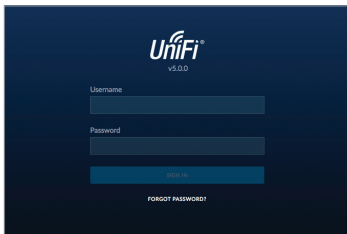

You can manage your network and view network statistics using the UniFi Controller management interface.

To adopt the UniFi Switch, proceed to the *Adopting the UniFi Switch* section.

For information on configuring and using the UniFi Controller software, refer to the User Guide on the website: documentation.ubnt.com/unifi

Adopting the UniFi Switch

1. From the UniFi Controller dashboard, click **Devices** in the left menu bar.



2. On the *Devices* screen, locate the UniFi Switch in the list of devices under the *Model* column. To adopt the UniFi Switch, click **Adopt**.

Name	Model	Status	Serial	MAC	Version	Adopted	Actions
AC-Flex-2500-10	UCR38110	Adopted	907 2966 6 F90 0306	A211-8600P	3.06.46		Adopt
AC-Flex-2500-11	UCR38110	Adopted	907 2966 6 F90 0306	A211-8600P	3.06.46		Adopt
AC-Flex-2500-12	UCR38110	Adopted	907 2966 6 F90 0306	A211-8600P	3.06.46		Adopt
AC-Flex-2500-13	UCR38110	Adopted	907 2966 6 F90 0306	A211-8600P	3.06.46		Adopt
AC-Flex-2500-14	UCR38110	Adopted	907 2966 6 F90 0306	A211-8600P	3.06.46		Adopt
AC-Flex-2500-15	UCR38110	Adopted	907 2966 6 F90 0306	A211-8600P	3.06.46		Adopt
AC-Flex-2500-16	UCR38110	Adopted	907 2966 6 F90 0306	A211-8600P	3.06.46		Adopt
AC-Flex-2500-17	UCR38110	Adopted	907 2966 6 F90 0306	A211-8600P	3.06.46		Adopt
AC-Flex-2500-18	UCR38110	Adopted	907 2966 6 F90 0306	A211-8600P	3.06.46		Adopt
AC-Flex-2500-19	UCR38110	Adopted	907 2966 6 F90 0306	A211-8600P	3.06.46		Adopt
AC-Flex-2500-20	UCR38110	Adopted	907 2966 6 F90 0306	A211-8600P	3.06.46		Adopt
AC-Flex-2500-21	UCR38110	Adopted	907 2966 6 F90 0306	A211-8600P	3.06.46		Adopt
AC-Flex-2500-22	UCR38110	Adopted	907 2966 6 F90 0306	A211-8600P	3.06.46		Adopt
AC-Flex-2500-23	UCR38110	Adopted	907 2966 6 F90 0306	A211-8600P	3.06.46		Adopt
AC-Flex-2500-24	UCR38110	Adopted	907 2966 6 F90 0306	A211-8600P	3.06.46		Adopt
AC-Flex-2500-25	UCR38110	Adopted	907 2966 6 F90 0306	A211-8600P	3.06.46		Adopt
AC-Flex-2500-26	UCR38110	Adopted	907 2966 6 F90 0306	A211-8600P	3.06.46		Adopt
AC-Flex-2500-27	UCR38110	Adopted	907 2966 6 F90 0306	A211-8600P	3.06.46		Adopt
AC-Flex-2500-28	UCR38110	Adopted	907 2966 6 F90 0306	A211-8600P	3.06.46		Adopt
AC-Flex-2500-29	UCR38110	Adopted	907 2966 6 F90 0306	A211-8600P	3.06.46		Adopt
AC-Flex-2500-30	UCR38110	Adopted	907 2966 6 F90 0306	A211-8600P	3.06.46		Adopt
AC-Flex-2500-31	UCR38110	Adopted	907 2966 6 F90 0306	A211-8600P	3.06.46		Adopt
AC-Flex-2500-32	UCR38110	Adopted	907 2966 6 F90 0306	A211-8600P	3.06.46		Adopt
AC-Flex-2500-33	UCR38110	Adopted	907 2966 6 F90 0306	A211-8600P	3.06.46		Adopt
AC-Flex-2500-34	UCR38110	Adopted	907 2966 6 F90 0306	A211-8600P	3.06.46		Adopt
AC-Flex-2500-35	UCR38110	Adopted	907 2966 6 F90 0306	A211-8600P	3.06.46		Adopt
AC-Flex-2500-36	UCR38110	Adopted	907 2966 6 F90 0306	A211-8600P	3.06.46		Adopt
AC-Flex-2500-37	UCR38110	Adopted	907 2966 6 F90 0306	A211-8600P	3.06.46		Adopt
AC-Flex-2500-38	UCR38110	Adopted	907 2966 6 F90 0306	A211-8600P	3.06.46		Adopt
AC-Flex-2500-39	UCR38110	Adopted	907 2966 6 F90 0306	A211-8600P	3.06.46		Adopt
AC-Flex-2500-40	UCR38110	Adopted	907 2966 6 F90 0306	A211-8600P	3.06.46		Adopt
AC-Flex-2500-41	UCR38110	Adopted	907 2966 6 F90 0306	A211-8600P	3.06.46		Adopt
AC-Flex-2500-42	UCR38110	Adopted	907 2966 6 F90 0306	A211-8600P	3.06.46		Adopt
AC-Flex-2500-43	UCR38110	Adopted	907 2966 6 F90 0306	A211-8600P	3.06.46		Adopt
AC-Flex-2500-44	UCR38110	Adopted	907 2966 6 F90 0306	A211-8600P	3.06.46		Adopt
AC-Flex-2500-45	UCR38110	Adopted	907 2966 6 F90 0306	A211-8600P	3.06.46		Adopt
AC-Flex-2500-46	UCR38110	Adopted	907 2966 6 F90 0306	A211-8600P	3.06.46		Adopt
AC-Flex-2500-47	UCR38110	Adopted	907 2966 6 F90 0306	A211-8600P	3.06.46		Adopt
AC-Flex-2500-48	UCR38110	Adopted	907 2966 6 F90 0306	A211-8600P	3.06.46		Adopt
AC-Flex-2500-49	UCR38110	Adopted	907 2966 6 F90 0306	A211-8600P	3.06.46		Adopt
AC-Flex-2500-50	UCR38110	Adopted	907 2966 6 F90 0306	A211-8600P	3.06.46		Adopt

3. The **System LED** on the UniFi Switch will turn blue to confirm that it has been successfully adopted.



640-00225-06

Configuring PoE Settings

By default, PoE settings for ports 1-8 are set to auto-sensing *PoE+*. PoE will automatically be activated on the port when an 802.3af/at device is connected. For 24V passive PoE, PoE must be manually activated.

! WARNING: Before manually activating 24V passive PoE, ensure that the connected device supports 24V passive PoE.

1. On the *Devices* screen, locate the UniFi Switch in the list of devices under the *Model* column. Click the switch to access its settings.

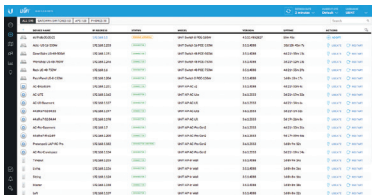

NAME	IP ADDRESS	STATUS	MODEL	VERSION	POWER	SEARCH
UniFi Switch 8 PoE 150W	192.168.1.1	CONNECTED	UniFi Switch 8 PoE 150W	4.12.0-44202	200 W	🔍
UniFi Switch 8 PoE 150W	192.168.1.2	CONNECTED	UniFi Switch 8 PoE 150W	4.12.0-44202	200 W	🔍
UniFi Switch 8 PoE 150W	192.168.1.3	CONNECTED	UniFi Switch 8 PoE 150W	4.12.0-44202	200 W	🔍
UniFi Switch 8 PoE 150W	192.168.1.4	CONNECTED	UniFi Switch 8 PoE 150W	4.12.0-44202	200 W	🔍
UniFi Switch 8 PoE 150W	192.168.1.5	CONNECTED	UniFi Switch 8 PoE 150W	4.12.0-44202	200 W	🔍
UniFi Switch 8 PoE 150W	192.168.1.6	CONNECTED	UniFi Switch 8 PoE 150W	4.12.0-44202	200 W	🔍
UniFi Switch 8 PoE 150W	192.168.1.7	CONNECTED	UniFi Switch 8 PoE 150W	4.12.0-44202	200 W	🔍
UniFi Switch 8 PoE 150W	192.168.1.8	CONNECTED	UniFi Switch 8 PoE 150W	4.12.0-44202	200 W	🔍
UniFi Switch 8 PoE 150W	192.168.1.9	CONNECTED	UniFi Switch 8 PoE 150W	4.12.0-44202	200 W	🔍
UniFi Switch 8 PoE 150W	192.168.1.10	CONNECTED	UniFi Switch 8 PoE 150W	4.12.0-44202	200 W	🔍
UniFi Switch 8 PoE 150W	192.168.1.11	CONNECTED	UniFi Switch 8 PoE 150W	4.12.0-44202	200 W	🔍
UniFi Switch 8 PoE 150W	192.168.1.12	CONNECTED	UniFi Switch 8 PoE 150W	4.12.0-44202	200 W	🔍
UniFi Switch 8 PoE 150W	192.168.1.13	CONNECTED	UniFi Switch 8 PoE 150W	4.12.0-44202	200 W	🔍
UniFi Switch 8 PoE 150W	192.168.1.14	CONNECTED	UniFi Switch 8 PoE 150W	4.12.0-44202	200 W	🔍
UniFi Switch 8 PoE 150W	192.168.1.15	CONNECTED	UniFi Switch 8 PoE 150W	4.12.0-44202	200 W	🔍
UniFi Switch 8 PoE 150W	192.168.1.16	CONNECTED	UniFi Switch 8 PoE 150W	4.12.0-44202	200 W	🔍
UniFi Switch 8 PoE 150W	192.168.1.17	CONNECTED	UniFi Switch 8 PoE 150W	4.12.0-44202	200 W	🔍
UniFi Switch 8 PoE 150W	192.168.1.18	CONNECTED	UniFi Switch 8 PoE 150W	4.12.0-44202	200 W	🔍
UniFi Switch 8 PoE 150W	192.168.1.19	CONNECTED	UniFi Switch 8 PoE 150W	4.12.0-44202	200 W	🔍
UniFi Switch 8 PoE 150W	192.168.1.20	CONNECTED	UniFi Switch 8 PoE 150W	4.12.0-44202	200 W	🔍
UniFi Switch 8 PoE 150W	192.168.1.21	CONNECTED	UniFi Switch 8 PoE 150W	4.12.0-44202	200 W	🔍
UniFi Switch 8 PoE 150W	192.168.1.22	CONNECTED	UniFi Switch 8 PoE 150W	4.12.0-44202	200 W	🔍
UniFi Switch 8 PoE 150W	192.168.1.23	CONNECTED	UniFi Switch 8 PoE 150W	4.12.0-44202	200 W	🔍
UniFi Switch 8 PoE 150W	192.168.1.24	CONNECTED	UniFi Switch 8 PoE 150W	4.12.0-44202	200 W	🔍
UniFi Switch 8 PoE 150W	192.168.1.25	CONNECTED	UniFi Switch 8 PoE 150W	4.12.0-44202	200 W	🔍
UniFi Switch 8 PoE 150W	192.168.1.26	CONNECTED	UniFi Switch 8 PoE 150W	4.12.0-44202	200 W	🔍
UniFi Switch 8 PoE 150W	192.168.1.27	CONNECTED	UniFi Switch 8 PoE 150W	4.12.0-44202	200 W	🔍
UniFi Switch 8 PoE 150W	192.168.1.28	CONNECTED	UniFi Switch 8 PoE 150W	4.12.0-44202	200 W	🔍
UniFi Switch 8 PoE 150W	192.168.1.29	CONNECTED	UniFi Switch 8 PoE 150W	4.12.0-44202	200 W	🔍
UniFi Switch 8 PoE 150W	192.168.1.30	CONNECTED	UniFi Switch 8 PoE 150W	4.12.0-44202	200 W	🔍
UniFi Switch 8 PoE 150W	192.168.1.31	CONNECTED	UniFi Switch 8 PoE 150W	4.12.0-44202	200 W	🔍
UniFi Switch 8 PoE 150W	192.168.1.32	CONNECTED	UniFi Switch 8 PoE 150W	4.12.0-44202	200 W	🔍
UniFi Switch 8 PoE 150W	192.168.1.33	CONNECTED	UniFi Switch 8 PoE 150W	4.12.0-44202	200 W	🔍
UniFi Switch 8 PoE 150W	192.168.1.34	CONNECTED	UniFi Switch 8 PoE 150W	4.12.0-44202	200 W	🔍
UniFi Switch 8 PoE 150W	192.168.1.35	CONNECTED	UniFi Switch 8 PoE 150W	4.12.0-44202	200 W	🔍
UniFi Switch 8 PoE 150W	192.168.1.36	CONNECTED	UniFi Switch 8 PoE 150W	4.12.0-44202	200 W	🔍
UniFi Switch 8 PoE 150W	192.168.1.37	CONNECTED	UniFi Switch 8 PoE 150W	4.12.0-44202	200 W	🔍
UniFi Switch 8 PoE 150W	192.168.1.38	CONNECTED	UniFi Switch 8 PoE 150W	4.12.0-44202	200 W	🔍
UniFi Switch 8 PoE 150W	192.168.1.39	CONNECTED	UniFi Switch 8 PoE 150W	4.12.0-44202	200 W	🔍
UniFi Switch 8 PoE 150W	192.168.1.40	CONNECTED	UniFi Switch 8 PoE 150W	4.12.0-44202	200 W	🔍
UniFi Switch 8 PoE 150W	192.168.1.41	CONNECTED	UniFi Switch 8 PoE 150W	4.12.0-44202	200 W	🔍
UniFi Switch 8 PoE 150W	192.168.1.42	CONNECTED	UniFi Switch 8 PoE 150W	4.12.0-44202	200 W	🔍
UniFi Switch 8 PoE 150W	192.168.1.43	CONNECTED	UniFi Switch 8 PoE 150W	4.12.0-44202	200 W	🔍
UniFi Switch 8 PoE 150W	192.168.1.44	CONNECTED	UniFi Switch 8 PoE 150W	4.12.0-44202	200 W	🔍
UniFi Switch 8 PoE 150W	192.168.1.45	CONNECTED	UniFi Switch 8 PoE 150W	4.12.0-44202	200 W	🔍
UniFi Switch 8 PoE 150W	192.168.1.46	CONNECTED	UniFi Switch 8 PoE 150W	4.12.0-44202	200 W	🔍
UniFi Switch 8 PoE 150W	192.168.1.47	CONNECTED	UniFi Switch 8 PoE 150W	4.12.0-44202	200 W	🔍
UniFi Switch 8 PoE 150W	192.168.1.48	CONNECTED	UniFi Switch 8 PoE 150W	4.12.0-44202	200 W	🔍
UniFi Switch 8 PoE 150W	192.168.1.49	CONNECTED	UniFi Switch 8 PoE 150W	4.12.0-44202	200 W	🔍
UniFi Switch 8 PoE 150W	192.168.1.50	CONNECTED	UniFi Switch 8 PoE 150W	4.12.0-44202	200 W	🔍

2. Click the **Ports** tab.

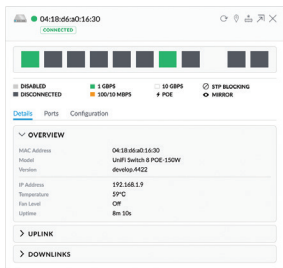

04:18:d6:a0:16:30
CONNECTED

DISABLED
DISCONNECTED

1 GBPS
100/10 MBPS

10 GBPS
+ POE

STP BLOCKING
MIRROR

Details Ports Configuration

OVERVIEW

MAC Address 04:18:d6:a0:16:30
Model UniFi Switch 8 PoE 150W
Version develop.4422

IP Address 192.168.1.9
Temperature 59°C
Fan Level OFF
Uptime 8m 10s

> UPLINK

> DOWNLINKS

3. Click **Actions** for the port you want to configure.



04:18:d6:a0:16:30
CONNECTED

DISABLED DISCONNECTED 1 GBPS 100/10 MBPS 10 GBPS POE STP BLOCKING MIRROR

Details **Ports** Configuration

PORT	NAME	STATUS	TX	RX	POE	NETWORKS/VLANs	ACTIONS
<input type="checkbox"/>	1	Port 1 1,000 FDX (Uplink)	41.4 KB	20.5 KB	PoE+	All	
<input checked="" type="checkbox"/>	2	Port 2	0 B	0 B	PoE+	All	
<input type="checkbox"/>	3	Port 3	0 B	0 B	PoE+	All	
<input type="checkbox"/>	4	Port 4	0 B	0 B	PoE+	All	
<input type="checkbox"/>	5	Port 5	0 B	0 B	PoE+	All	
<input type="checkbox"/>	6	Port 6	0 B	0 B	PoE+	All	
<input type="checkbox"/>	7	Port 7 1,000 FDX	117 KB	47.9 KB	PoE+	All	
<input type="checkbox"/>	8	Port 8	0 B	0 B	PoE+	All	
<input type="checkbox"/>	9	SFP 1	0 B	0 B	All		
<input type="checkbox"/>	10	SFP 2	0 B	0 B	All		

EDIT SELECTED

4. Select the appropriate mode: **Off**, **24V Passive**, or **PoE+** from the *PoE* setting. Then click **Apply**.

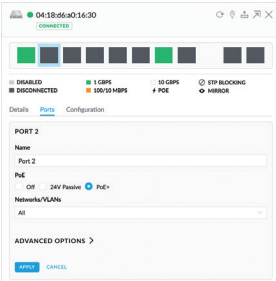

04:18:d6:a0:16:30
CONNECTED

DISABLED DISCONNECTED 1 GBPS 100/10 MBPS 10 GBPS POE STP BLOCKING MIRROR

Details **Ports** Configuration

PORT 2

Name
Port 2

PoE
 Off 24V Passive PoE+

Networks/VLANs
All

ADVANCED OPTIONS >

APPLY CANCEL

For more information, refer to the User Guide on the website:
documentation.ubnt.com/unifi

Specifications

UniFi Switch US-8-150W	
Dimensions	204 x 43 x 235 mm (8.03 x 1.69 x 9.25")
Weight	1.65 kg (3.64 lb)
With Mount Brackets	1.73 kg (3.81 lb)
Interfaces	
Networking	(8) 10/100/1000 Mbps RJ45 Ports (2) 1 Gbps SFP Ports
Management	Ethernet In-Band
Power Method	100-240VAC/50-60 Hz, Universal Input
Power Supply	AC/DC, Internal, 150W DC
Max. Power Consumption	
Including PoE Output	150W
Excluding PoE Output	20W
Processor Specs	ARM Cortex-A9 400 MHz
Memory Information	256MB DDR3
Code Storage	32 MB NOR Flash
Line Rate	10 Gbps, Non-Blocking
LEDs	
System	Status
RJ45 Data Ports	PoE; Link/Speed/Activity
SFP Data Ports	Link/Speed/Activity
PoE Output (RJ45 Ports)	IEEE 802.3at/af 2-Pair (+1, 2; -3, 6); Passive 24V/0.7A 2-Pair (+4, 5; -7, 8)
ESD/EMP Protection	± 24kV Air, ± 24kV Contact
Shock and Vibration	ETSI300-019-1.4 Standard
Operating Temperature	-5 to 45° C (23 to 113° F)
Operating Humidity	5 to 95% Noncondensing
Certifications	CE, FCC, IC

Safety Notices

1. Read, follow, and keep these instructions.
2. Heed all warnings.
3. Only use attachments/accessories specified by the manufacturer.



WARNING: Failure to provide proper ventilation may cause fire hazard. Keep at least 20mm of clearance next to the ventilation holes for adequate airflow.



WARNING: To reduce the risk of fire or electric shock, do not expose this product to rain or moisture.



WARNING: Do not use this product in location that can be submerged by water.



WARNING: Avoid using this product during an electrical storm. There may be a remote risk of electric shock from lightning.

Electrical Safety Information

1. Compliance is required with respect to voltage, frequency, and current requirements indicated on the manufacturer's label. Connection to a different power source than those specified may result in improper operation, damage to the equipment or pose a fire hazard if the limitations are not followed.
2. There are no operator serviceable parts inside this equipment. Service should be provided only by a qualified service technician.
3. This equipment is provided with a detachable power cord which has an integral safety ground wire intended for connection to a grounded safety outlet.
 - a. Do not substitute the power cord with one that is not the provided approved type. Never use an adapter plug to connect to a 2-wire outlet as this will defeat the continuity of the grounding wire.
 - b. The equipment requires the use of the ground wire as a part of the safety certification, modification or misuse can provide a shock hazard that can result in serious injury or death.
 - c. Contact a qualified electrician or the manufacturer if there are questions about the installation prior to connecting the equipment.
 - d. Protective earthing is provided by Listed AC adapter. Building installation shall provide appropriate short-circuit backup protection.
 - e. Protective bonding must be installed in accordance with local national wiring rules and regulations.

Limited Warranty

UBIQUITI NETWORKS, Inc (“UBIQUITI NETWORKS”) warrants that the product(s) furnished hereunder (the “Product(s)”) shall be free from defects in material and workmanship for a period of one (1) year from the date of shipment by UBIQUITI NETWORKS under normal use and operation. UBIQUITI NETWORKS’ sole and exclusive obligation and liability under the foregoing warranty shall be for UBIQUITI NETWORKS, at its discretion, to repair or replace any Product that fails to conform to the above warranty during the above warranty period. The expense of removal and reinstallation of any Product is not included in this warranty. The warranty period of any repaired or replaced Product shall not extend beyond its original term.

Warranty Conditions

The above warranty does not apply if the Product:

- (I) has been modified and/or altered, or an addition made thereto, except by Ubiquiti Networks, or Ubiquiti Networks’ authorized representatives, or as approved by Ubiquiti Networks in writing;
- (II) has been painted, rebranded or physically modified in any way;
- (III) has been damaged due to errors or defects in cabling;
- (IV) has been subjected to misuse, abuse, negligence, abnormal physical, electromagnetic or electrical stress, including lightning strikes, or accident;
- (V) has been damaged or impaired as a result of using third party firmware;
- (VI) has no original Ubiquiti MAC label, or is missing any other original Ubiquiti label(s); or
- (VII) has not been received by Ubiquiti within 30 days of issuance of the RMA.

In addition, the above warranty shall apply only if: the product has been properly installed and used at all times in accordance, and in all material respects, with the applicable Product documentation; all Ethernet cabling runs use CAT5 (or above), and for outdoor installations, shielded Ethernet cabling is used, and for indoor installations, indoor cabling requirements are followed.

Returns

No Products will be accepted for replacement or repair without obtaining a Return Materials Authorization (RMA) number from UBIQUITI NETWORKS during the warranty period, and the Products being received at UBIQUITI NETWORKS' facility freight prepaid in accordance with the RMA process of UBIQUITI NETWORKS. Products returned without an RMA number will not be processed and will be returned freight collect or subject to disposal. Information on the RMA process and obtaining an RMA number can be found at: www.ubnt.com/support/warranty.

Disclaimer

EXCEPT FOR ANY EXPRESS WARRANTIES PROVIDED HEREIN, UBIQUITI NETWORKS, ITS AFFILIATES, AND ITS AND THEIR THIRD PARTY DATA, SERVICE, SOFTWARE AND HARDWARE PROVIDERS HEREBY DISCLAIM AND MAKE NO OTHER REPRESENTATION OR WARRANTY OF ANY KIND, EXPRESS, IMPLIED OR STATUTORY, INCLUDING, BUT NOT LIMITED TO, REPRESENTATIONS, GUARANTEES, OR WARRANTIES OF MERCHANTABILITY, ACCURACY, QUALITY OF SERVICE OR RESULTS, AVAILABILITY, SATISFACTORY QUALITY, LACK OF VIRUSES, QUIET ENJOYMENT, FITNESS FOR A PARTICULAR PURPOSE AND NON-INFRINGEMENT AND ANY WARRANTIES ARISING FROM ANY COURSE OF DEALING, USAGE OR TRADE PRACTICE IN CONNECTION WITH SUCH PRODUCTS AND SERVICES. BUYER ACKNOWLEDGES THAT NEITHER UBIQUITI NETWORKS NOR ITS THIRD PARTY PROVIDERS CONTROL BUYER'S EQUIPMENT OR THE TRANSFER OF DATA OVER COMMUNICATIONS FACILITIES, INCLUDING THE INTERNET, AND THAT THE PRODUCTS AND SERVICES MAY BE SUBJECT TO LIMITATIONS, INTERRUPTIONS, DELAYS, CANCELLATIONS AND OTHER PROBLEMS INHERENT IN THE USE OF COMMUNICATIONS FACILITIES. UBIQUITI NETWORKS, ITS AFFILIATES AND ITS AND THEIR THIRD PARTY PROVIDERS ARE NOT RESPONSIBLE FOR ANY INTERRUPTIONS, DELAYS, CANCELLATIONS, DELIVERY FAILURES, DATA LOSS, CONTENT CORRUPTION, PACKET LOSS, OR OTHER DAMAGE RESULTING FROM ANY OF THE FOREGOING. In addition, UBIQUITI NETWORKS does not warrant that the operation of the Products will be error-free or that operation will be uninterrupted. In no event shall UBIQUITI NETWORKS be responsible for damages or claims of any nature or description relating to system performance, including coverage, buyer's selection of products (including the Products) for buyer's application and/or failure of products (including the Products) to meet government or regulatory requirements.

Limitation of Liability

EXCEPT TO THE EXTENT PROHIBITED BY LOCAL LAW, IN NO EVENT WILL UBIQUITI OR ITS SUBSIDIARIES, AFFILIATES OR SUPPLIERS BE LIABLE FOR DIRECT, SPECIAL, INCIDENTAL, CONSEQUENTIAL OR OTHER DAMAGES (INCLUDING LOST PROFIT, LOST DATA, OR DOWNTIME COSTS), ARISING OUT OF THE USE, INABILITY TO USE, OR THE RESULTS OF USE OF THE PRODUCT, WHETHER BASED IN WARRANTY, CONTRACT, TORT OR OTHER LEGAL THEORY, AND WHETHER OR NOT ADVISED OF THE POSSIBILITY OF SUCH DAMAGES.

Note

Some countries, states and provinces do not allow exclusions of implied warranties or conditions, so the above exclusion may not apply to you. You may have other rights that vary from country to country, state to state, or province to province. Some countries, states and provinces do not allow the exclusion or limitation of liability for incidental or consequential damages, so the above limitation may not apply to you. EXCEPT TO THE EXTENT ALLOWED BY LOCAL LAW, THESE WARRANTY TERMS DO NOT EXCLUDE, RESTRICT OR MODIFY, AND ARE IN ADDITION TO, THE MANDATORY STATUTORY RIGHTS APPLICABLE TO THE LICENSE OF ANY SOFTWARE (EMBEDDED IN THE PRODUCT) TO YOU. The United Nations Convention on Contracts for the International Sale of Goods shall not apply to any transactions regarding the sale of the Products.

Compliance

FCC

Changes or modifications not expressly approved by the party responsible for compliance could void the user's authority to operate the equipment.

This device complies with Part 15 of the FCC Rules. Operation is subject to the following two conditions:

1. This device may not cause harmful interference, and
2. This device must accept any interference received, including interference that may cause undesired operation.

NOTE: This equipment has been tested and found to comply with the limits for a Class A digital device, pursuant to part 15 of the FCC Rules. These limits are designed to provide reasonable protection against harmful interference when the equipment is operated in a commercial environment. This equipment generates, uses, and can radiate radio frequency energy and, if not installed and used in accordance with the instruction manual, may cause harmful interference to radio communications. Operations of this equipment in a residential area is likely to cause harmful interference in which case the user will be required to correct the interference at his own expense.

Industry Canada

CAN ICES-3(A)/NMB-3(A)

This Class A digital apparatus complies with Canadian CAN ICES-3(A).

CAN ICES-3(A)/NMB-3(A)

Cet appareil numérique de la classe A est conforme à la norme NMB-3(A) Canada.

Australia and New Zealand



Warning: This is a Class A product. In a domestic environment this product may cause radio interference in which case the user may be required to take adequate measures.

CE Marking

CE marking on this product represents the product is in compliance with all directives that are applicable to it.



RoHS/WEEE Compliance Statement



English

European Directive 2012/19/EU requires that the equipment bearing this symbol on the product and/or its packaging must not be disposed of with unsorted municipal waste. The symbol indicates that this product should be disposed of separately from regular household waste streams. It is your responsibility to dispose of this and other electric and electronic equipment via designated collection facilities appointed by the government or local authorities. Correct disposal and recycling will help prevent potential negative consequences to the environment and human health. For more detailed information about the disposal of your old equipment, please contact your local authorities, waste disposal service, or the shop where you purchased the product.

Deutsch

Die Europäische Richtlinie 2012/19/EU verlangt, dass technische Ausrüstung, die direkt am Gerät und/oder an der Verpackung mit diesem Symbol versehen ist, nicht zusammen mit unsortiertem Gemeindeabfall entsorgt werden darf. Das Symbol weist darauf hin, dass das Produkt von regulärem Haushaltsmüll getrennt entsorgt werden sollte. Es liegt in Ihrer Verantwortung, dieses Gerät und andere elektrische und elektronische Geräte über die dafür zuständigen und von der Regierung oder örtlichen Behörden dazu bestimmten Sammelstellen zu entsorgen. Ordnungsgemäßes Entsorgen und Recyceln trägt dazu bei, potentielle negative Folgen für Umwelt und die menschliche Gesundheit zu vermeiden. Wenn Sie weitere Informationen zur Entsorgung Ihrer Altgeräte benötigen, wenden Sie sich bitte an die örtlichen Behörden oder städtischen Entsorgungsdienste oder an den Händler, bei dem Sie das Produkt erworben haben.

Español

La Directiva 2012/19/UE exige que los equipos que lleven este símbolo en el propio aparato y/o en su embalaje no deben eliminarse junto con otros residuos urbanos no seleccionados. El símbolo indica que el producto en cuestión debe separarse de los residuos domésticos convencionales con vistas a su eliminación. Es responsabilidad suya desechar este y cualesquiera otros aparatos eléctricos y electrónicos a través de los puntos de recogida que ponen a su disposición el gobierno y las autoridades locales. Al desechar y reciclar correctamente estos aparatos estará contribuyendo a evitar posibles consecuencias negativas para el medio ambiente y la salud de las personas. Si desea obtener información más detallada sobre la eliminación segura de su aparato usado, consulte a las autoridades locales, al servicio de recogida y eliminación de residuos de su zona o pregunte en la tienda donde adquirió el producto.

Français

La directive européenne 2012/19/UE exige que l'équipement sur lequel est apposé ce symbole sur le produit et/ou son emballage ne soit pas jeté avec les autres ordures ménagères. Ce symbole indique que le produit doit être éliminé dans un circuit distinct de celui pour les déchets des ménages. Il est de votre responsabilité de jeter ce matériel ainsi que tout autre matériel électrique ou électronique par les moyens de collecte indiqués par le gouvernement et les pouvoirs publics des collectivités territoriales. L'élimination et le recyclage en bonne et due forme ont pour but de lutter contre l'impact néfaste potentiel de ce type de produits sur l'environnement et la santé publique. Pour plus d'informations sur le mode d'élimination de votre ancien équipement, veuillez prendre contact avec les pouvoirs publics locaux, le service de traitement des déchets, ou l'endroit où vous avez acheté le produit.

Italiano

La direttiva europea 2012/19/UE richiede che le apparecchiature contrassegnate con questo simbolo sul prodotto e/o sull'imballaggio non siano smaltite insieme ai rifiuti urbani non differenziati. Il simbolo indica che questo prodotto non deve essere smaltito insieme ai normali rifiuti domestici. È responsabilità del proprietario smaltire sia questi prodotti sia le altre apparecchiature elettriche ed elettroniche mediante le specifiche strutture di raccolta indicate dal governo o dagli enti pubblici locali. Il corretto smaltimento ed il riciclaggio aiuteranno a prevenire conseguenze potenzialmente negative per l'ambiente e per la salute dell'essere umano. Per ricevere informazioni più dettagliate circa lo smaltimento delle vecchie apparecchiature in Vostro possesso, Vi invitiamo a contattare gli enti pubblici di competenza, il servizio di smaltimento rifiuti o il negozio nel quale avete acquistato il prodotto.

Declaration of Conformity

Česky [Czech]	UBIQUITI NETWORKS tímto prohlašuje, že toto UBIQUITI NETWORKS zařízení, je ve shod se základními požadavky a dalšími příslušnými ustanoveními směrnic 2014/30/EU, 2014/35/EU.
Dansk [Danish]	Hermed, UBIQUITI NETWORKS, erklærer at denne UBIQUITI NETWORKS enhed, er i overensstemmelse med de væsentlige krav og øvrige relevante krav i direktiver 2014/30/EU, 2014/35/EU.
Nederlands [Dutch]	Hierbij verklaart UBIQUITI NETWORKS, dat deze UBIQUITI NETWORKS apparaat, in overeenstemming is met de essentiële eisen en de andere relevante bepalingen van richtlijnen 2014/30/EU, 2014/35/EU.
English	Hereby, UBIQUITI NETWORKS, declares that this UBIQUITI NETWORKS device, is in compliance with the essential requirements and other relevant provisions of Directives 2014/30/EU, 2014/35/EU.
Eesti [Estonian]	Käesolevaga UBIQUITI NETWORKS kinnitab, et antud UBIQUITI NETWORKS seade, on vastavus olulistele nõuetele ja teistele asjakohastele sätetele direktiivide 2014/30/EL, 2014/35/EL.
Suomi [Finnish]	Täten UBIQUITI NETWORKS vakuuttaa, että tämä UBIQUITI NETWORKS laite, on yhdenmukainen olennaisten vaatimusten ja muiden sitä koskevien direktiivien 2014/30/EU, 2014/35/EU.
Français [French]	Par la présente UBIQUITI NETWORKS déclare que l'appareil UBIQUITI NETWORKS, est conforme aux exigences essentielles et aux autres dispositions pertinentes des directives 2014/30/UE, 2014/35/UE.
Deutsch [German]	Hiermit erklärt UBIQUITI NETWORKS, dass sich dieses UBIQUITI NETWORKS Gerät, in Übereinstimmung mit den grundlegenden Anforderungen und den anderen relevanten Vorschriften der Richtlinien 2014/30/EU, 2014/35/EU befindet.
Ελληνική [Greek]	Δια του παρόντος, UBIQUITI NETWORKS, δηλώνει ότι αυτή η συσκευή UBIQUITI NETWORKS, είναι σε συμμόρφωση με τις βασικές απαιτήσεις και τις λοιπές σχετικές διατάξεις των οδηγιών 2014/30/ΕΕ, 2014/35/ΕΕ.
Magyar [Hungarian]	Ezennel UBIQUITI NETWORKS kijelenti, hogy ez a UBIQUITI NETWORKS készülék megfelel az alapvető követelményeknek és más vonatkozó 2014/30/EU, 2014/35/EU irányelvek rendelkezéseit.
Íslenska [Icelandic]	Hér, UBIQUITI NETWORKS, því yfir að þetta UBIQUITI NETWORKS tæki er í samræmi við grunnkröfur og önnur viðeigandi ákvæði tilskipana 2014/30/ESB, 2014/35/ESB.
Italiano [Italian]	Con la presente, UBIQUITI NETWORKS, dichiara che questo dispositivo UBIQUITI NETWORKS, è conforme ai requisiti essenziali ed alle altre disposizioni pertinenti delle direttive 2014/30/UE, 2014/35/UE.
Latviski [Latvian]	Ar šo, UBIQUITI NETWORKS, deklarē, ka UBIQUITI NETWORKS ierīce, ir saskaņā ar būtiskajām prasībām un citiem attiecīgiem noteikumiem Direktīvās 2014/30/ES, 2014/35/ES.

Lietuviškai [Lithuanian]	UBIQUITI NETWORKS deklaruoja, kad šis UBIQUITI NETWORKS įrenginys atitinka esminius reikalavimus ir kitas 2014/30/ES, 2014/35/ES Direktyvų nuostatas.
Malti [Maltese]	Hawnhekk, UBIQUITI NETWORKS, tiddikjara li dan il-mezz UBIQUITI NETWORKS huwa konformi mar-rekwiżiti essenzjali u dispożizzjonijiet rilevanti oħrajn ta 'Direttivi 2014/30/UE, 2014/35/UE.
Norsk [Norwegian]	Herved UBIQUITI NETWORKS, erklærer at denne UBIQUITI NETWORKS enheten, er i samsvar med de grunnleggende kravene og andre relevante bestemmelser i direktivene 2014/30/EU, 2014/35/EU.
Polski [Polish]	Niniejszym, Ubiquiti Networks, oświadcza, że urządzenie UBIQUITI NETWORKS, jest zgodny z zasadniczymi wymaganiami oraz pozostałymi stosownymi postanowieniami Dyrektyw 2014/30/UE, 2014/35/UE.
Português [Portuguese]	UBIQUITI NETWORKS declara que este dispositivo UBIQUITI NETWORKS, está conforme com os requisitos essenciais e outras disposições das Directivas 2014/30/UE, 2014/35/UE.
Română [Romanian]	Prin prezenta, UBIQUITI NETWORKS declară că acest dispozitiv UBIQUITI NETWORKS este în conformitate cu cerințele esențiale și alte prevederi relevante ale Directivelor 2014/30/UE, 2014/35/UE.
Slovensky [Slovak]	Týmto UBIQUITI NETWORKS, prehlasuje, že toto UBIQUITI NETWORKS zariadenie, je v súlade so základnými požiadavkami a ďalšími relevantnými ustanoveniami smernice 2014/30/EÚ, 2014/35/EÚ.
Español [Spanish]	Por medio de la presente UBIQUITI NETWORKS declara que este dispositivo UBIQUITI NETWORKS, cumple con los requisitos esenciales y cualesquiera otras disposiciones aplicables o exigibles de las Directivas 2014/30/UE, 2014/35/UE.
Svenska [Swedish]	Härmed UBIQUITI NETWORKS, intygar att denna UBIQUITI NETWORKS enhet är i överensstämmelse med de väsentliga egenskapskrav och övriga relevanta bestämmelser som framgår av direktiven 2014/30/EU, 2014/35/EU.

Online Resources

Support help.ubnt.com

Community community.ubnt.com

Downloads downloads.ubnt.com



www.ubnt.com

©2015-2016 Ubiquiti Networks, Inc. All rights reserved. Ubiquiti, Ubiquiti Networks, the Ubiquiti U logo, the Ubiquiti beam logo, and UniFi are trademarks or registered trademarks of Ubiquiti Networks, Inc. in the United States and in other countries. All other trademarks are the property of their respective owners.

PHA1060116